

# Why Multi-layer Traffic Engineering Still Matters: Slicing the transport network to support 5G

**Daniel King** – [d.king@lancaster.ac.uk](mailto:d.king@lancaster.ac.uk)

Lancaster University (British Telecom & Intel Co-Lab)

**Young Lee** – [ylee@huawei.com](mailto:ylee@huawei.com)

**Qin Wu** – [bill.wu@huawei.com](mailto:bill.wu@huawei.com)

Huawei Technologies

**Adrian Farrel** – [adrian@olddog.co.uk](mailto:adrian@olddog.co.uk)

Old Dog Consulting



# 5G PPP Objective KPIs and Use Cases



- 1000 times higher mobile data volume per geographical area
- 10 to 100 times higher typical user data rate
- 10 times lower energy consumption
- End to end latency < 1ms
- Scalable management framework enabling fast deployment of novel applications
- Reduction of the network management OPEX by at least 20% compared to today
- **Slicing of Network Resources**

## Enhanced Mobile Broadband

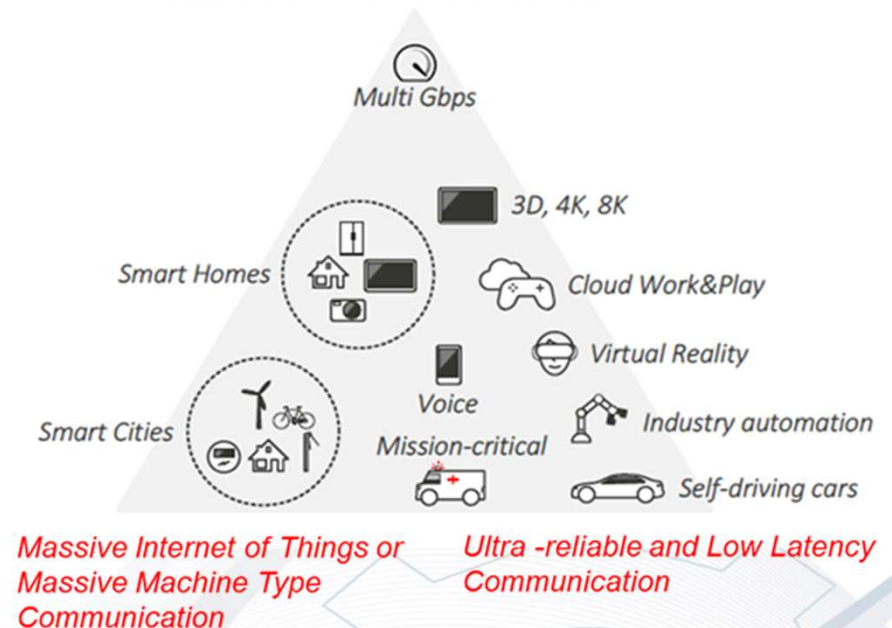

# 5G Network Slicing

## H2020 Metro-Haul Objectives



- **What is Metro-Haul?**

- The aim of this project is to design and build a smart optical metro infrastructure able to support traffic originating from heterogeneous 5G access networks
- Find out more at: [metro-haul.eu](http://metro-haul.eu)

- **Architect and design cost-effective, energy-efficient, agile and programmable metro networks**

- Scalable for 5G access and future requirements
- Design of all-optical metro nodes (including full compute and storage capabilities)
- Interface with both 5G access and multi-Tbit/s elastic core networks.

- **Challenges:**

- *Optical challenge*, cost effective and agile, involving both the optical architecture and also innovative new optical component technologies -> disaggregated white boxes
- *Network management challenge*. SDN/NFV control framework supporting 5G operational and both end-user and vertical oriented services, including slicing.
- *Monitoring challenge*. Implementation & AI-based tools for interpreting vast amounts of data

# What is Network Slicing?

## In the context of the 5G Transport Network

### TE Network Slicing Definition (from the ACTN Framework)

*In the context of ACTN, a TE network slice is a collection of resources that is used to establish a logically dedicated virtual network over one or more TE networks. TE network slicing allows a network operator to provide dedicated virtual networks for applications/customers over a common network infrastructure.*

*The logically dedicated resources are a part of the larger common network infrastructures that are shared among various TE network slice instances which are the end-to-end realization of TE network slicing, consisting of the combination of physically or logically dedicated resources.*

### Essentially network slicing (in the context of ACTN) provides Traffic Engineered Network Slices

- Connectivity to serve customers with a wide variety of service
- Constraints, which may be characterised with metrics: latency, reliability, capacity, and service function specific capabilities

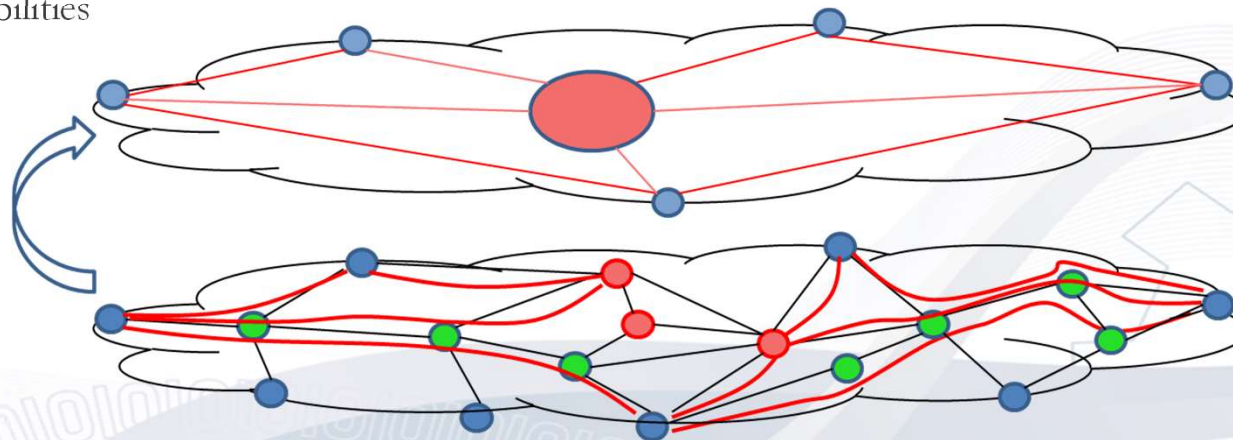

# What is ACTN?

## Abstraction and Control of TE Networks (ACTN)



- Abstraction is a way of representing connectivity across a TE network
- This allows a server network to present connectivity options to a client
- ACTN is an architecture for requesting and managing abstractions
- A customer (a client) requests connectivity from an operator
  - Delivered as a VN or a TE topology
- ACTN components map the customer requests to network resources
  - Orchestration can select and instruct networks
  - Controllers can program the network devices
  - TE links (tunnels), abstract nodes, and virtual networks are constructed
  - Services are mapped to the TE resources

# 5G Slice Orchestration and Control

## Using the IETF ACTN Framework

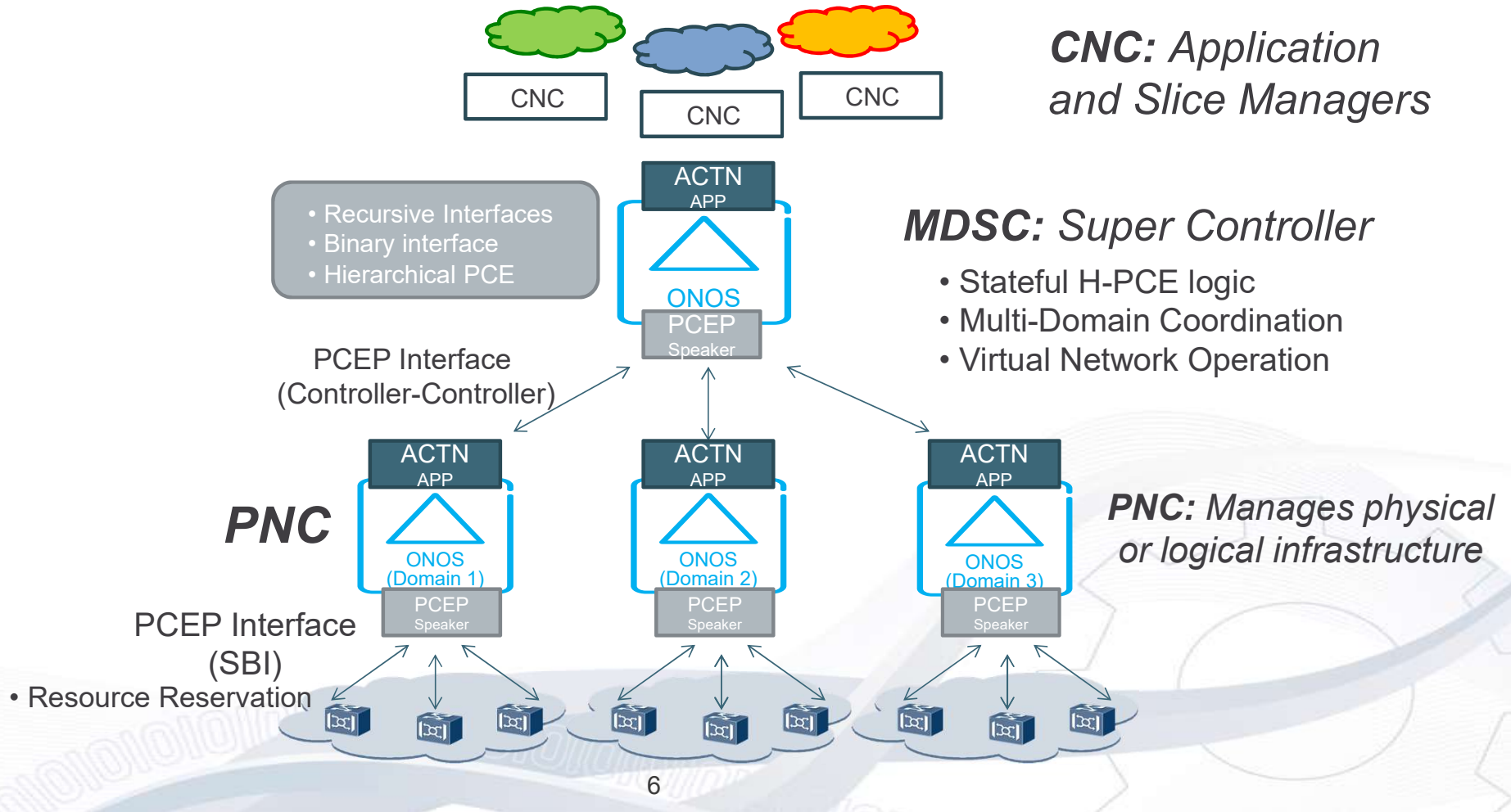

# Key ACTN Building Blocks for 5G Transport Network Slicing

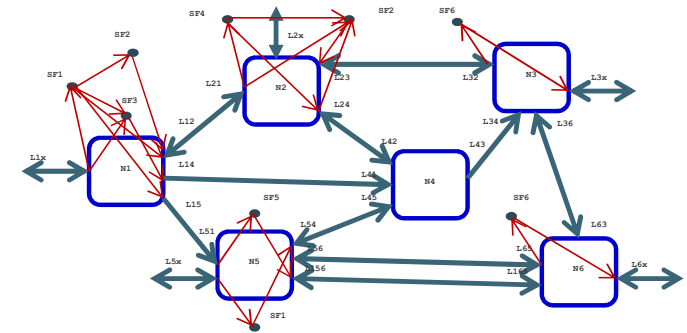
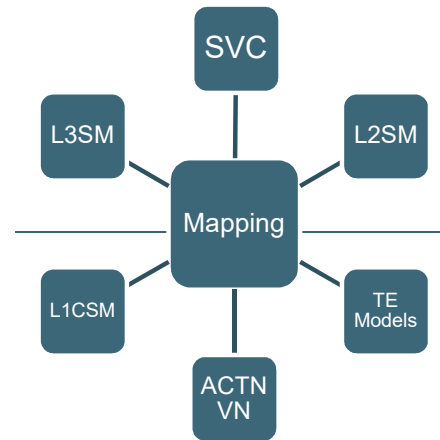
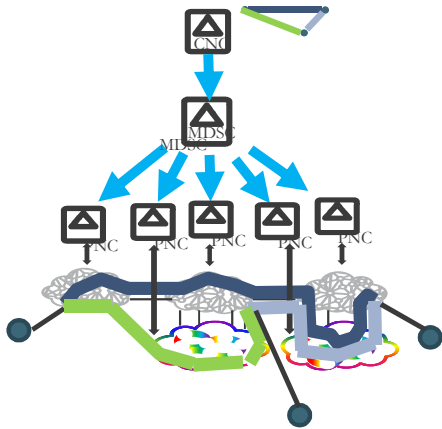

Problem Statement and Architecture for Information Exchange between TE Networks  
<https://www.rfc-editor.org/rfc/rfc7926.txt>  
 Framework for Abstraction and Control of TE Networks  
[www.rfc-editor.org/rfc/rfc8453.txt](https://www.rfc-editor.org/rfc/rfc8453.txt)  
 Applicability of Abstraction and Control of Traffic Engineered Networks (ACTN) to Network Slicing  
[draft-ietf-teas-applicability-actn-slicing-03.txt](https://www.rfc-editor.org/rfc/rfc8299.txt)

YANG Data Model L3VPN Service Delivery  
[www.rfc-editor.org/rfc/rfc8299.txt](https://www.rfc-editor.org/rfc/rfc8299.txt)  
 A YANG Data Model L2VPN Service Delivery  
[draft-ietf-l2sm-l2vpn-service-model-10.txt](https://www.rfc-editor.org/rfc/rfc8299.txt)  
 A YANG Data Model L1 Connectivity SM  
[draft-ietf-ccamp-l1csm-yang-08.txt](https://www.rfc-editor.org/rfc/rfc8299.txt)  
 A Yang Data Model for ACTN VN Operation  
[draft-ietf-teas-actn-vn-yang-02.txt](https://www.rfc-editor.org/rfc/rfc8299.txt)

SF Aware TE Topology YANG Model  
[draft-ietf-teas-sf-aware-topo-model-02](https://www.rfc-editor.org/rfc/rfc8299.txt)

# Why Service Models are critical for Automation and Resource Mapping

- ACTN maps service requests to underlying network constructs
  - Services to VNs and TE
  - VNs to TE
- Service Mapping Model exposes this
  - Critical for diagnostics
  - Also enables direct control

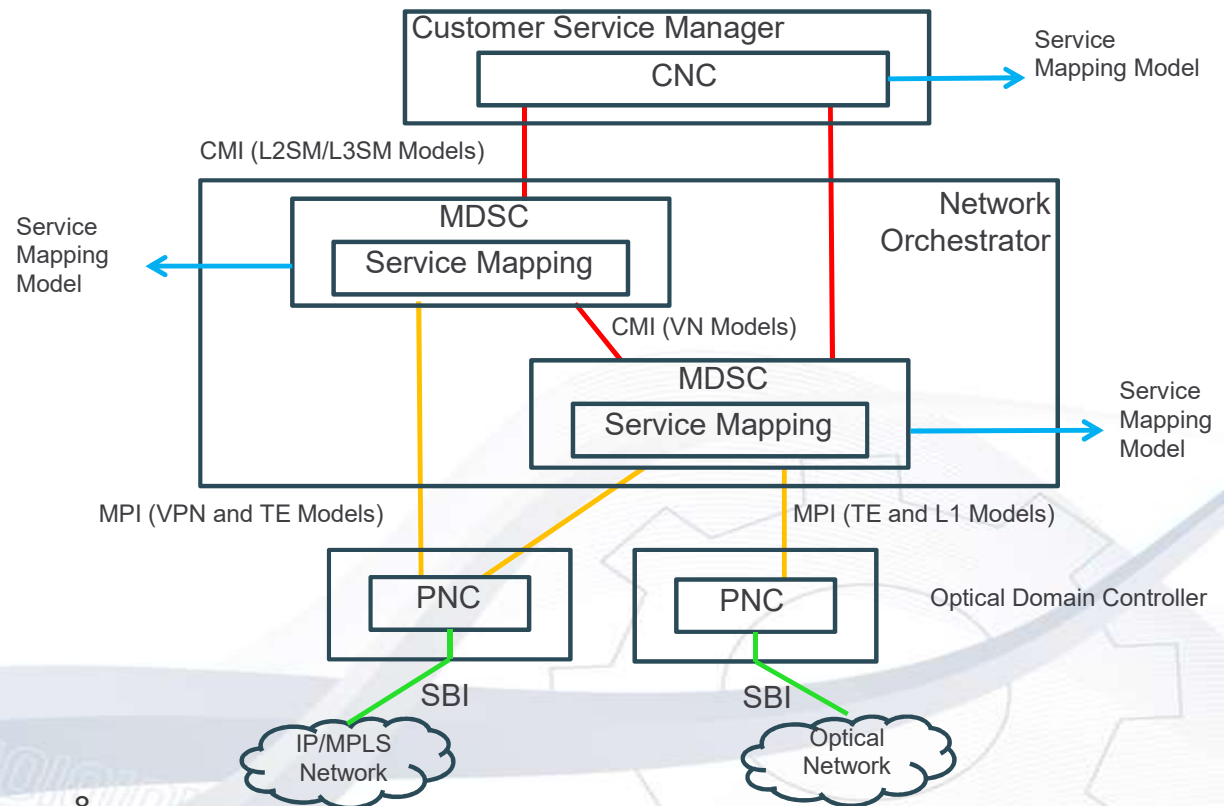



# Moving Beyond the Theoretical

## Network slicing and multi-layer networking with Metro-Haul

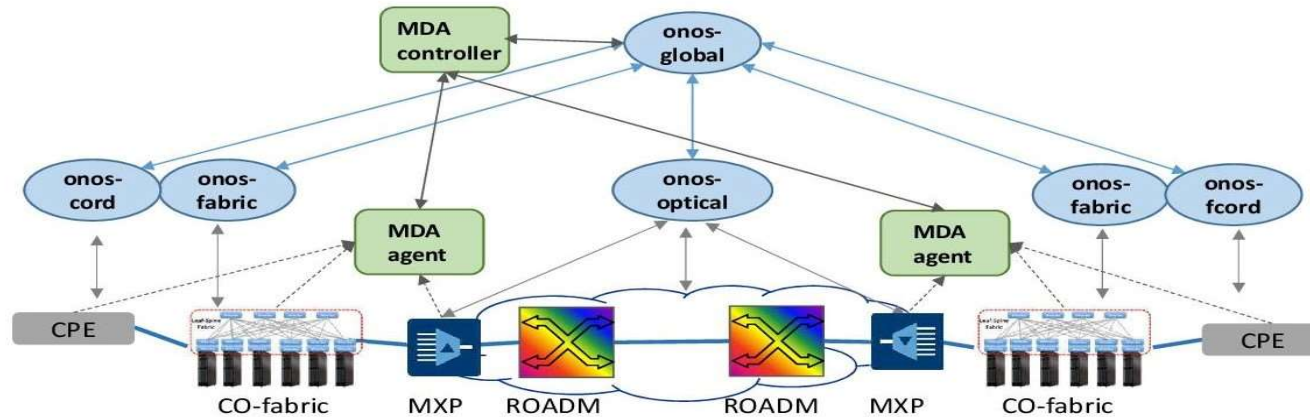

The MDSC (named ONOS global) coordinates three domains (IP, Ethernet and Optical) and a total of five ONOS (PNC) instances

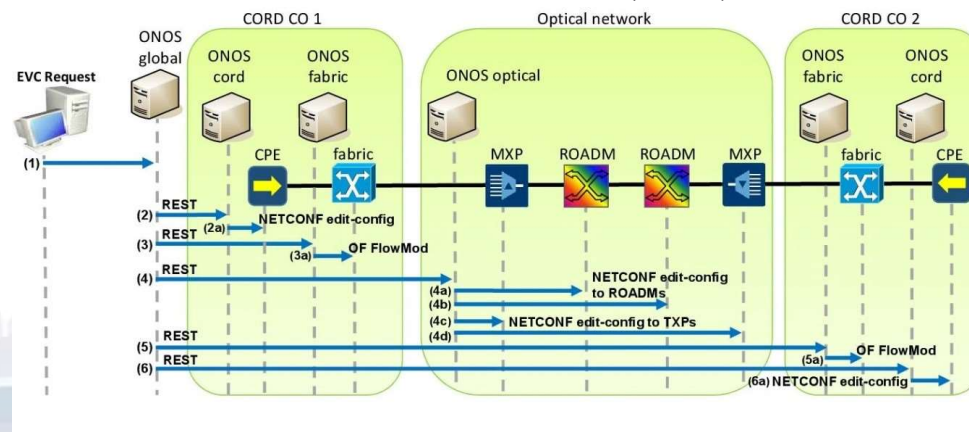

Watch this recent ECOC2018 Demo  
[https://youtu.be/AO8\\_rb5ZLBA](https://youtu.be/AO8_rb5ZLBA)

# What Additional SDO Work is Needed?

## Combination of Formal and Defecto Standards Development



- **Virtual Network Service (VNS) Security and Isolation**
  - Secure slicing and isolation of resources
    - Consumers may expect and require that there is no risk of leakage of data from one slice to another
    - No transfer of knowledge of the structure or even existence of other slices, and that changes to one slice (under the control of one consumer) should not have detrimental effects on the operation of other slices
  - Policy control of slices
    - Managing who and how the VNS creation and modification will be achieved, and also the scope of slice setup and possible modifications/re-optimizations
- **Requesting compute, storage and function resources during VNS setup**
  - Including VNF type, size, location and ensuring correct service chains
  - Additional YANG modules
- **Telemetry Messaging Protocols and Data Modeling**
  - Frequency, data type and state management

# Thank You!



Any comments or questions are welcome.

Daniel King

[d.king@lancaster.ac.uk](mailto:d.king@lancaster.ac.uk)

Young Lee

[ylee@huawei.com](mailto:ylee@huawei.com)

Qin Wu

[bill.wu@huawei.com](mailto:bill.wu@huawei.com)

Adrian Farrel

[adrian@olddog.co.uk](mailto:adrian@olddog.co.uk)



<http://metro-haul.eu>

*METRO-HAUL: METRO High bandwidth, 5G Application-aware optical network, with edge storage, compute and low Latency*

H2020-ICT-2016-2 Metro-Haul Grant No. 761727